

POTABLE WATER TYPICAL CONNECTION FOR MULTIPLE SERVICES * 5W

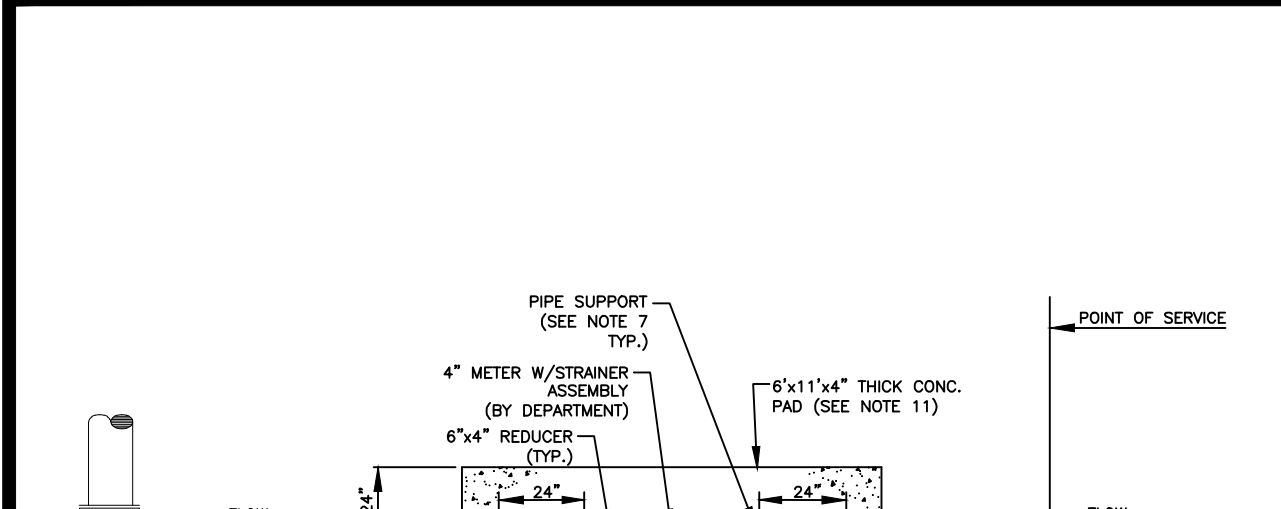

POTABLE WATER SERVICE SINGLE 5/8\"/>

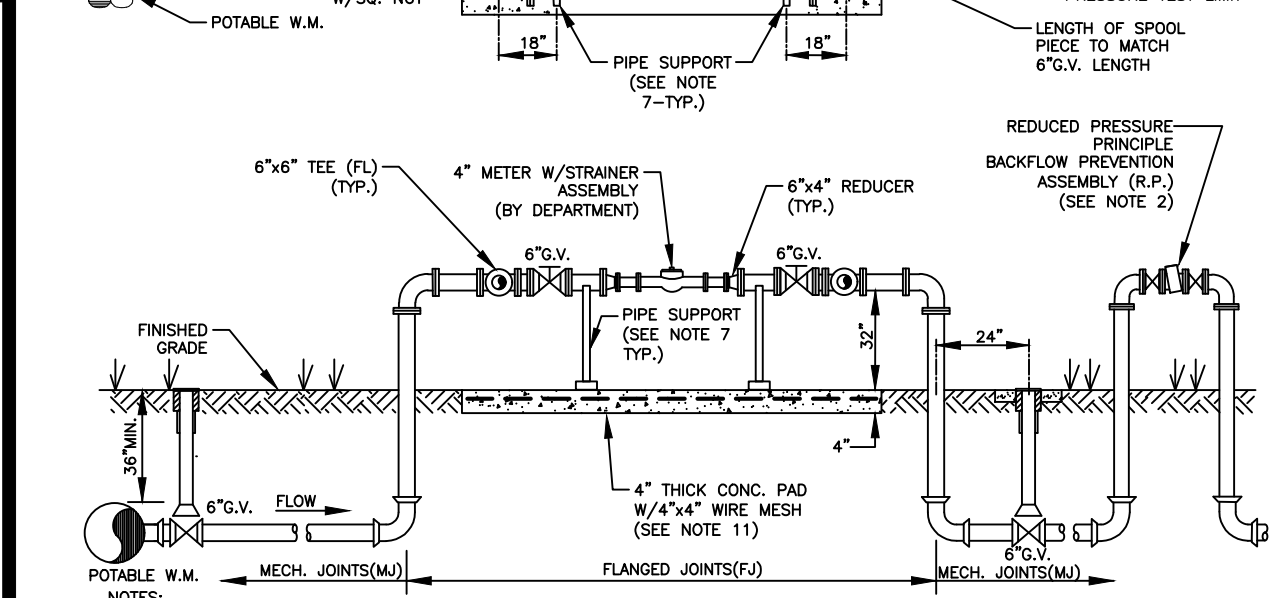

POTABLE WATER SERVICE DUAL 5/8\"/>

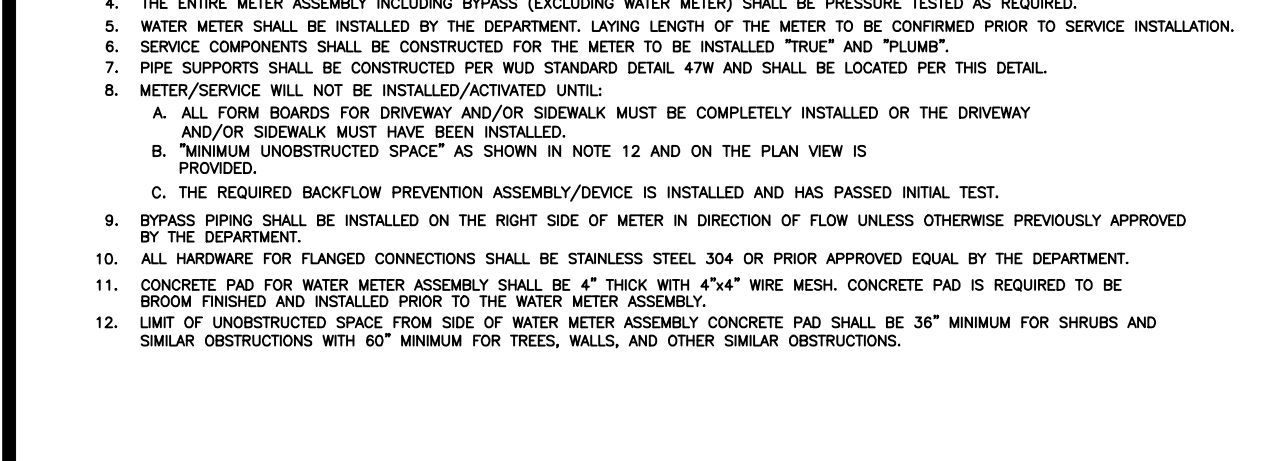

POTABLE WATER 4\"/>

CONSULTANT:

DESIGNED BY: WUD

DRAWN BY: M. BUCKNER

CHECKED BY: J. LAMMERT

APPROVED BY: WUD

Palm Beach County
Water Utilities Department
P.O. Box
West Palm Beach, FL 33416-6097

Feb 27, 2023

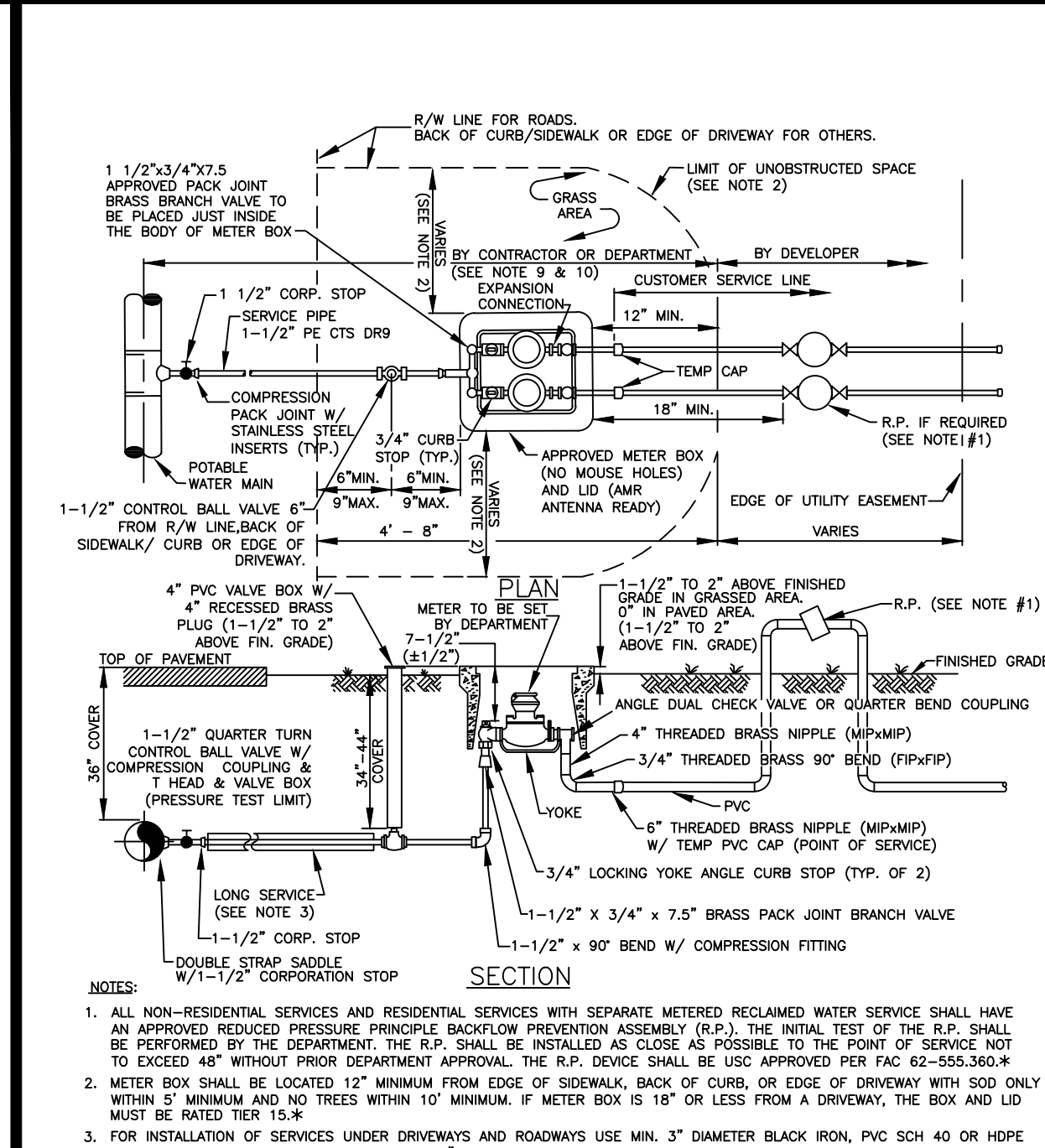

POTABLE WATER SERVICE DUAL 5/8\"/>

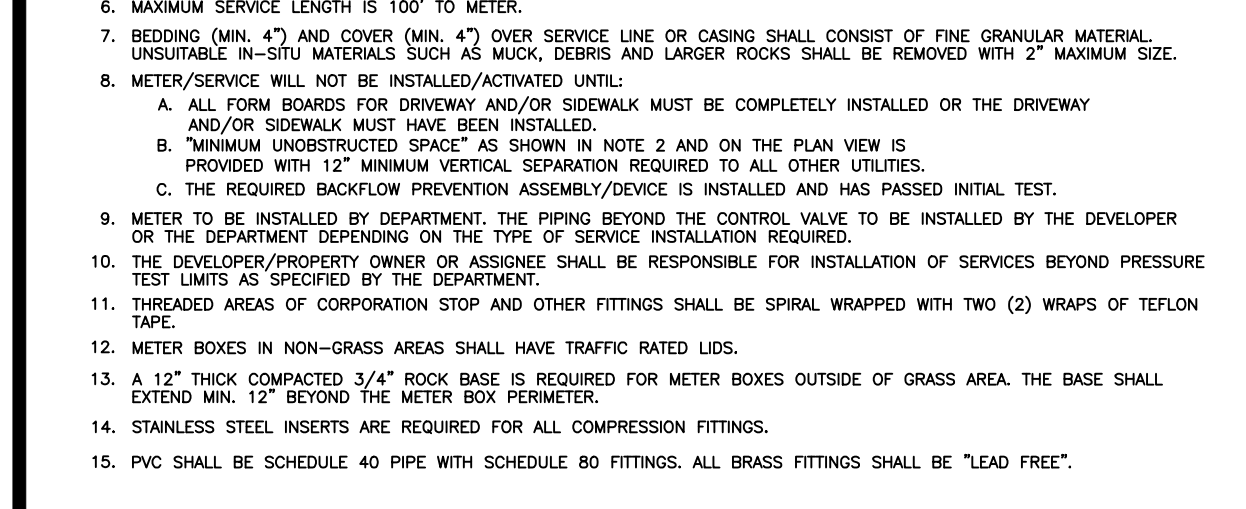

POTABLE WATER SERVICE DUAL 5/8\"/>

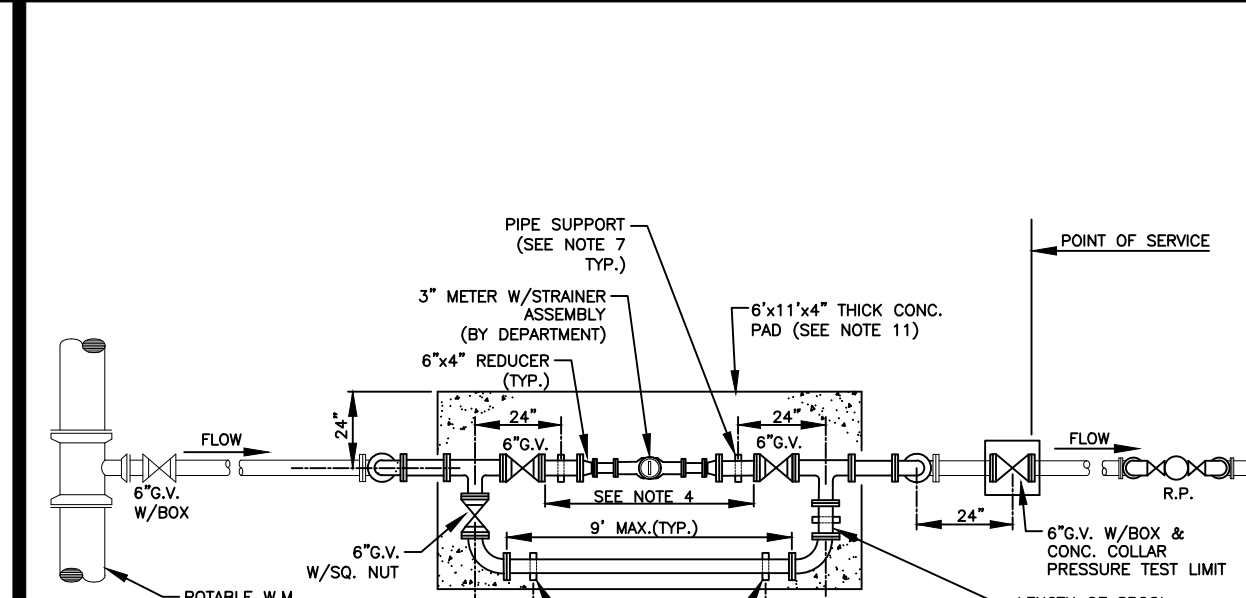

POTABLE WATER 3\"/>

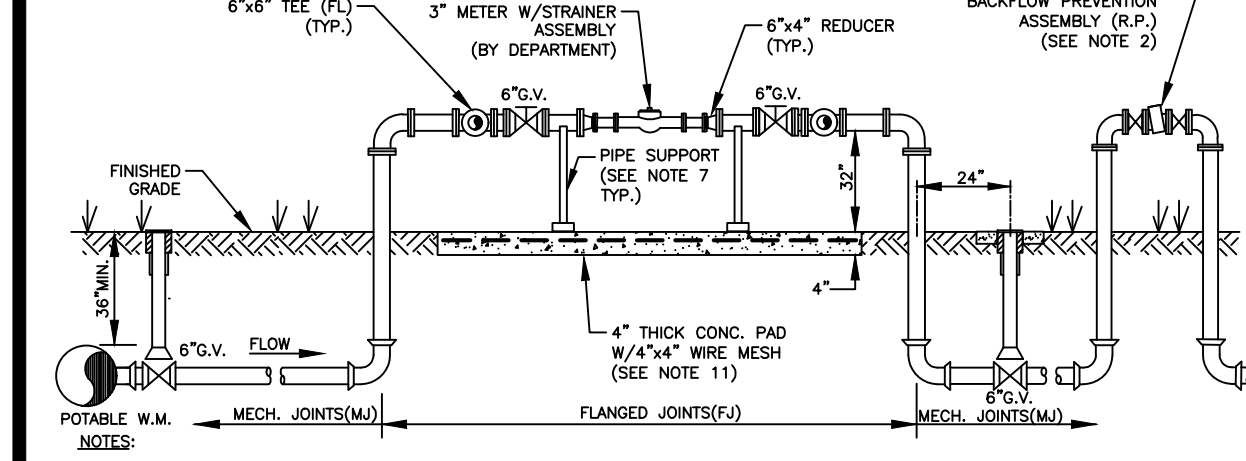

POTABLE WATER 3\"/>

IT'S THE LAW!

CALL US BEFORE YOU DIG

1-800-432-4770

SUNSHINE STATE OF FLORIDA, INC.
UTILITIES NOTIFICATION CENTER

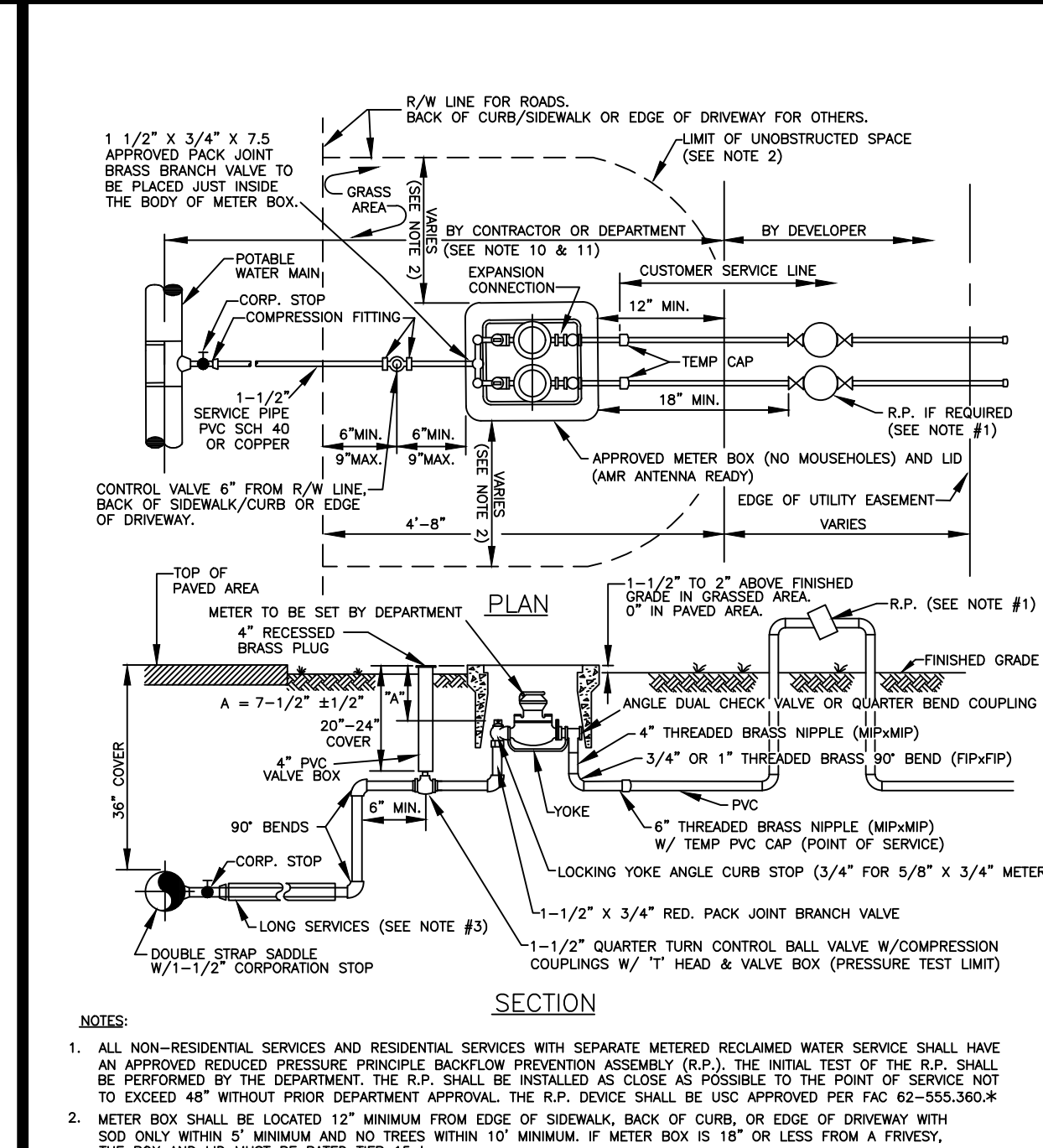

POTABLE WATER SERVICE DUAL 5/8\"/>

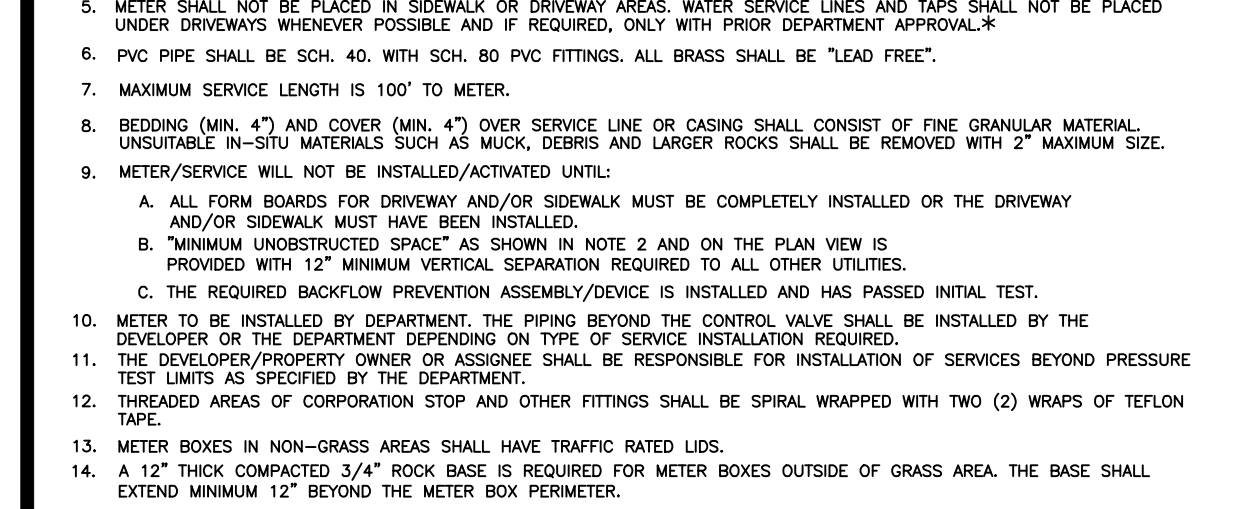

POTABLE WATER SERVICE DUAL 5/8\"/>

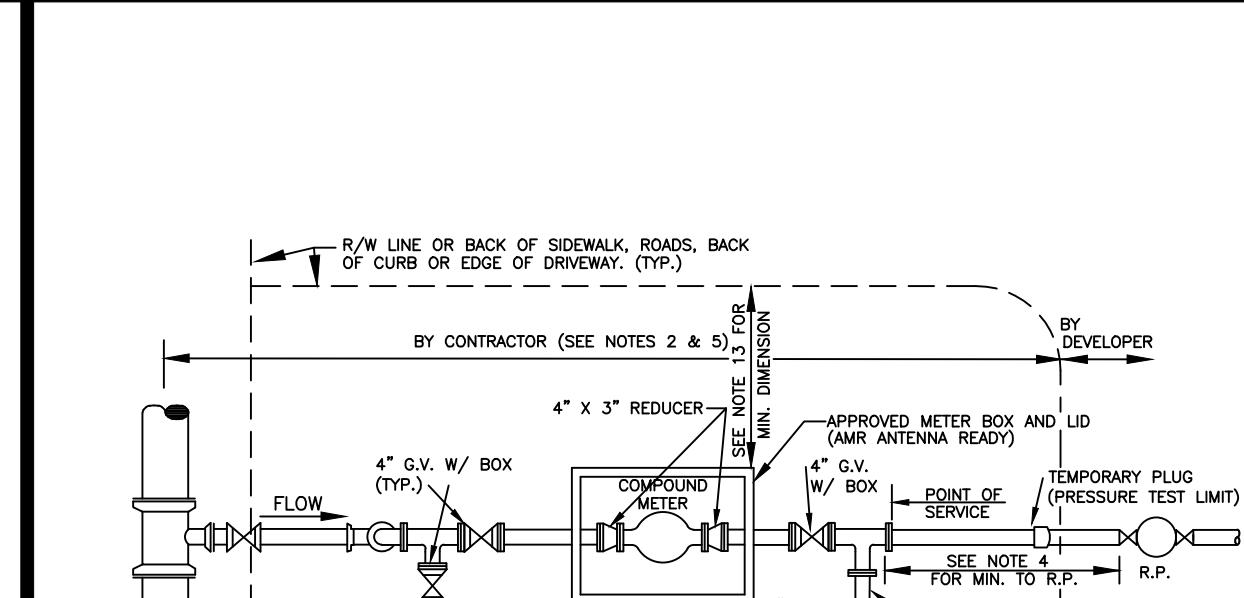

POTABLE WATER 3\"/>

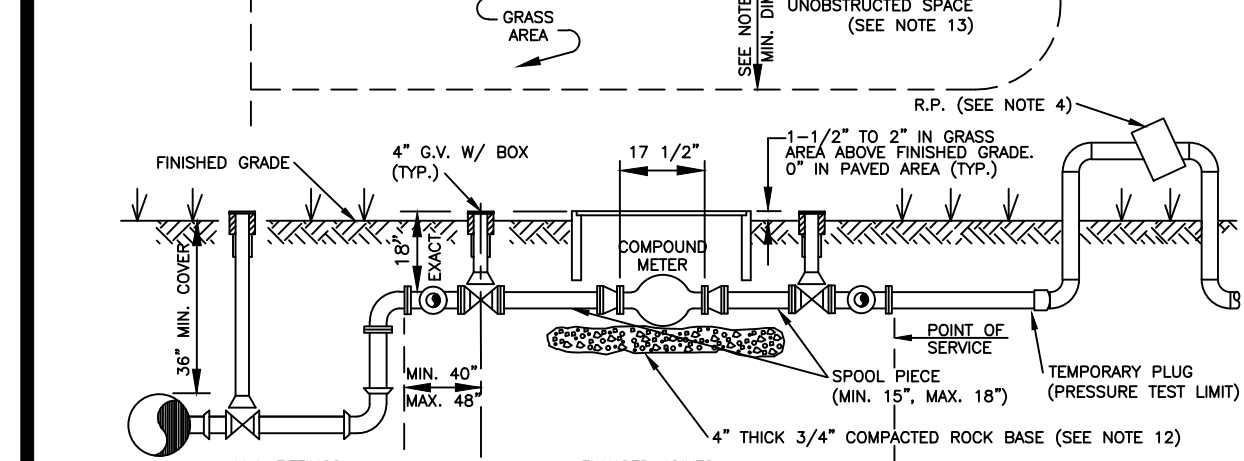

POTABLE WATER 3\"/>

IT'S THE LAW!

CALL US BEFORE YOU DIG

1-800-432-4770

SUNSHINE STATE OF FLORIDA, INC.
UTILITIES NOTIFICATION CENTER

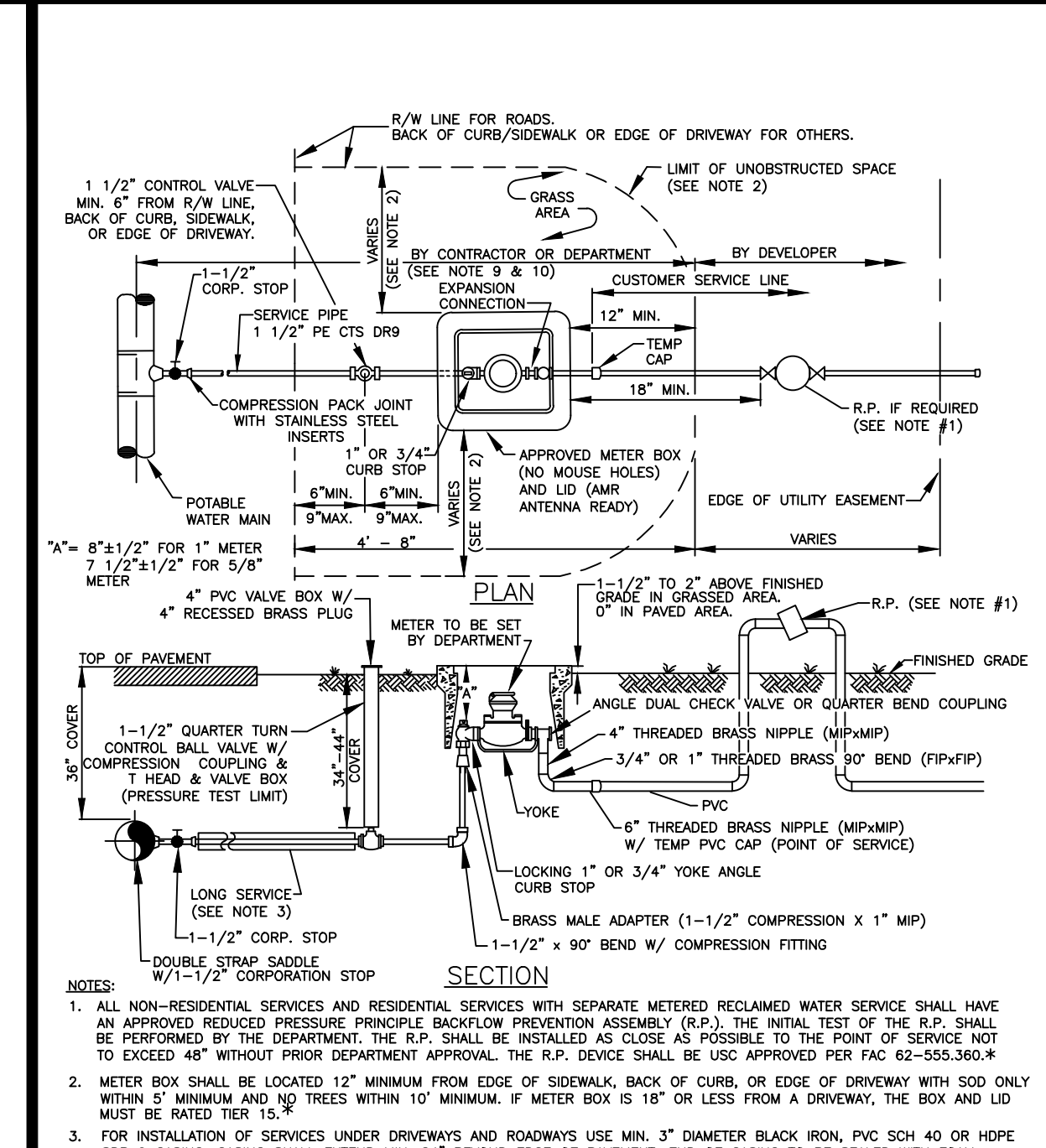

POTABLE WATER SERVICE SINGLE 5/8\"/>

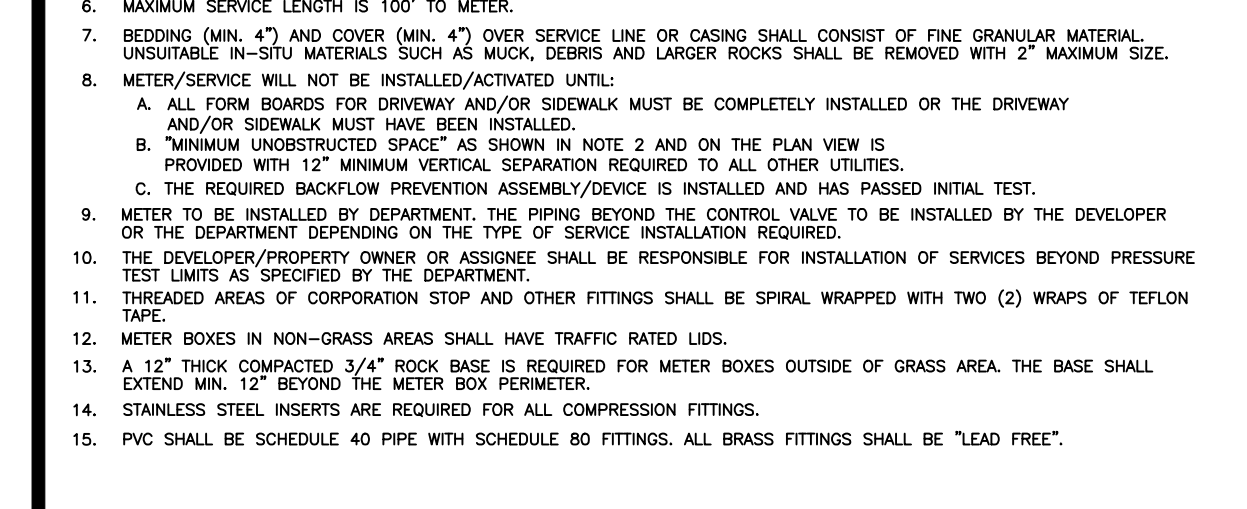

POTABLE WATER SERVICE SINGLE 5/8\"/>

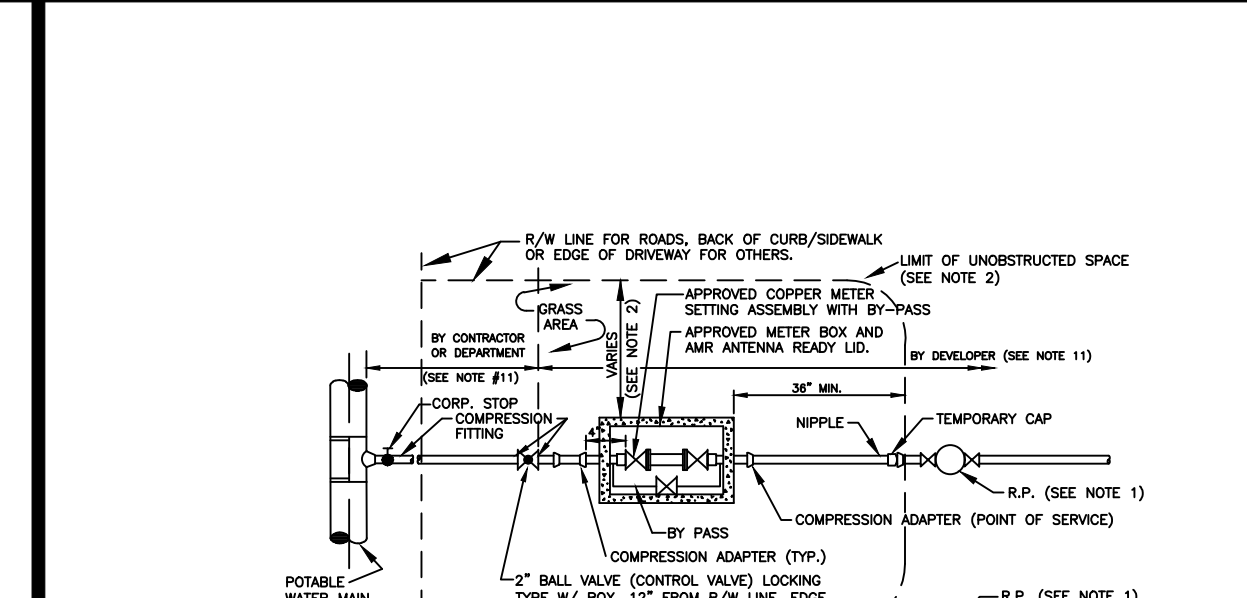

POTABLE WATER 3\"/>

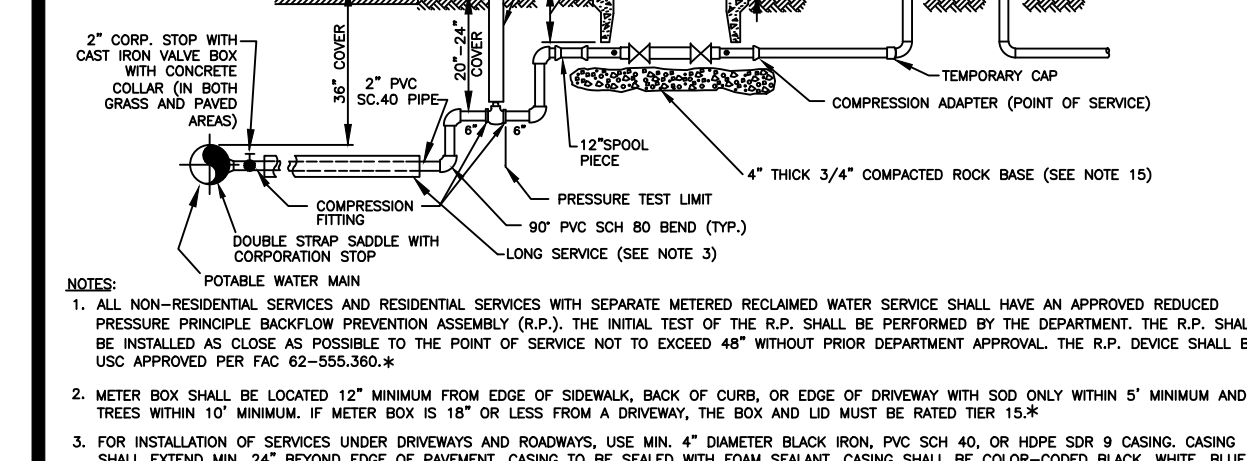

POTABLE WATER 3\"/>

IT'S THE LAW!

CALL US BEFORE YOU DIG

1-800-432-4770

SUNSHINE STATE OF FLORIDA, INC.
UTILITIES NOTIFICATION CENTER

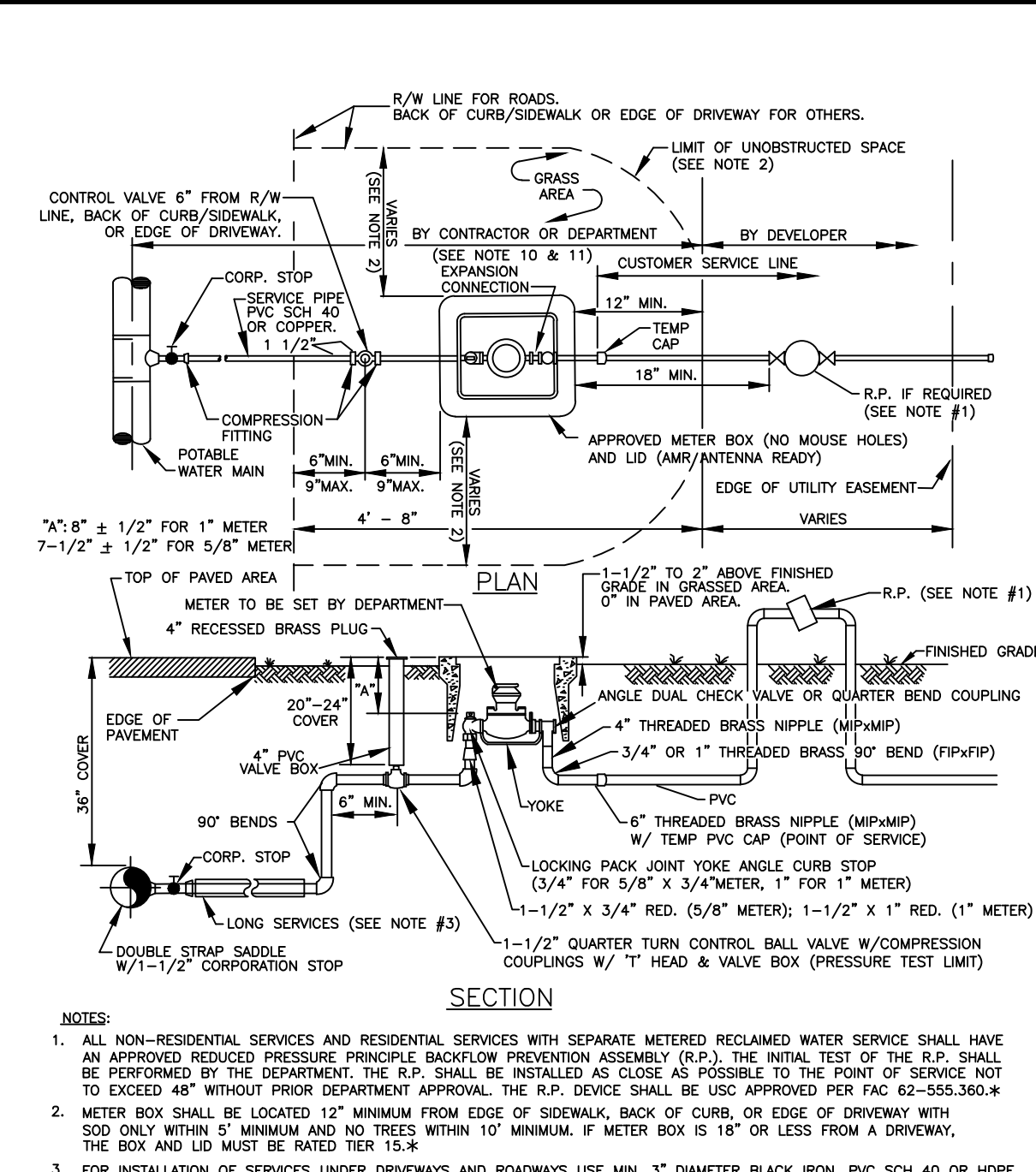

POTABLE WATER SERVICE SINGLE 5/8\"/>

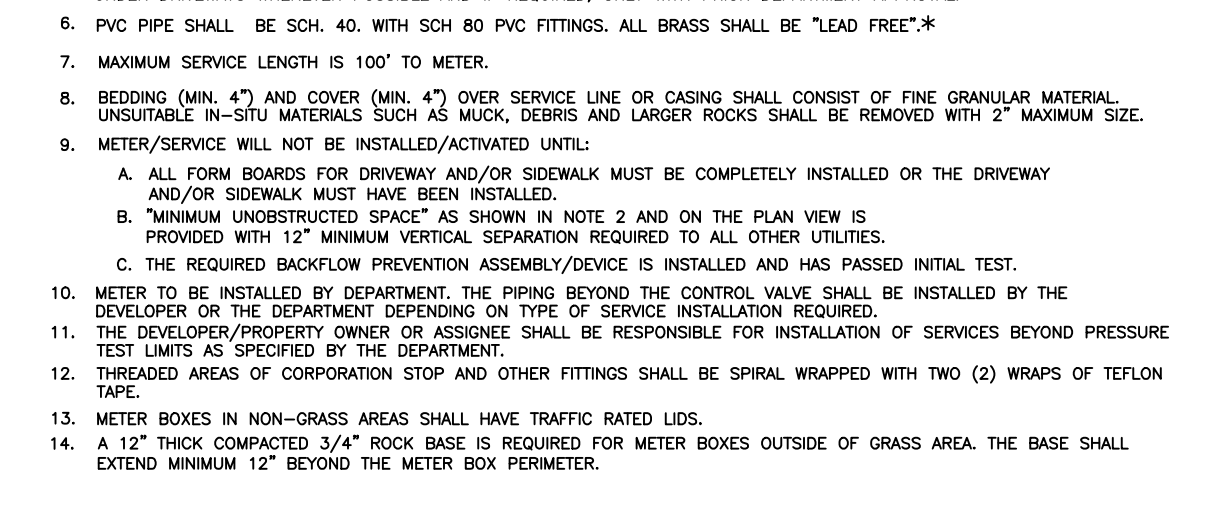

POTABLE WATER SERVICE SINGLE 5/8\"/>

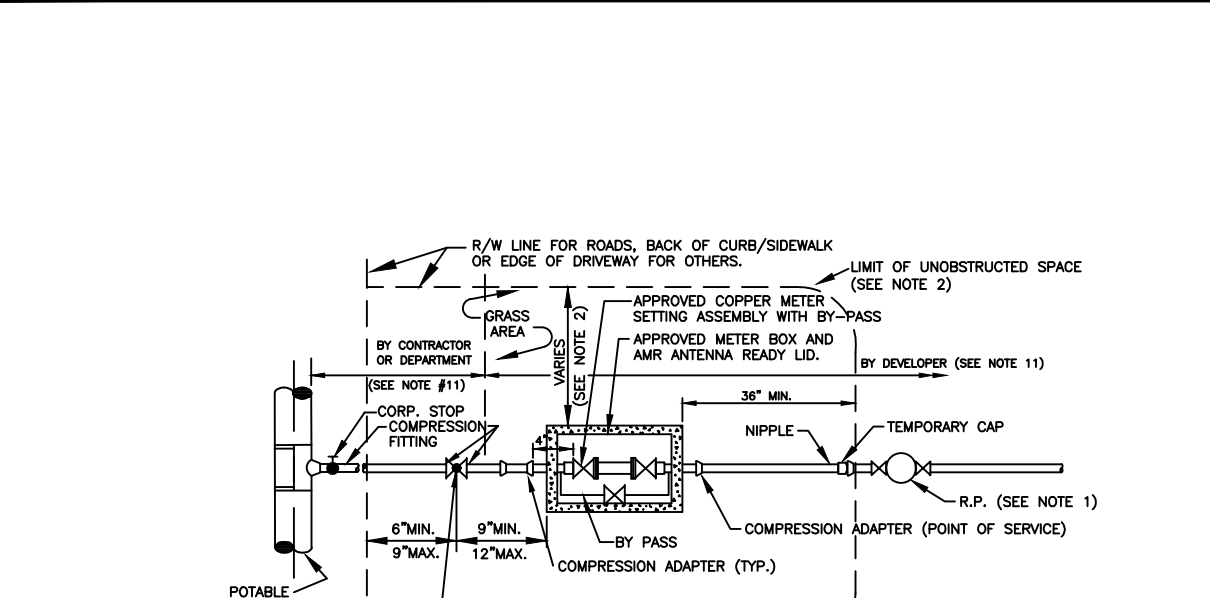

POTABLE WATER 3\"/>

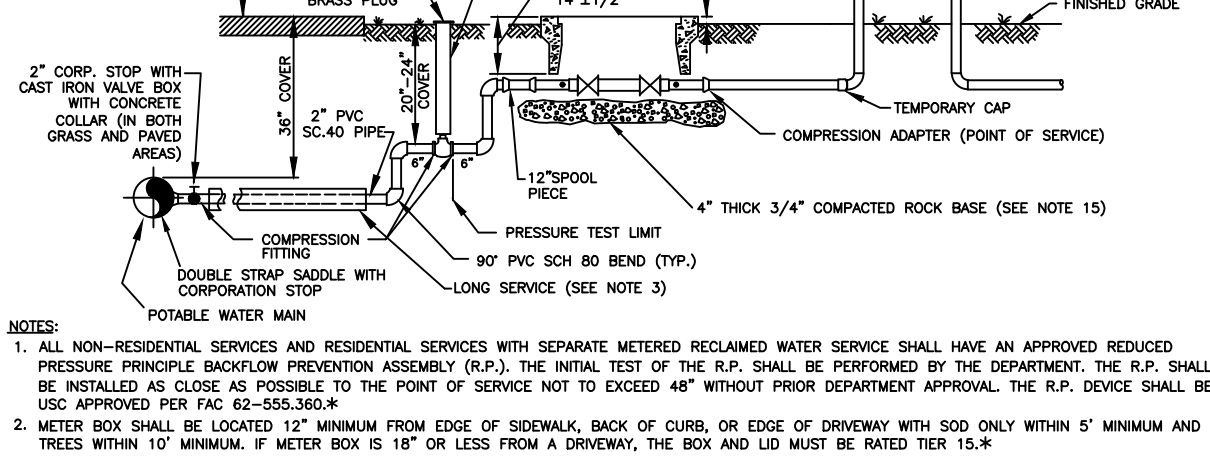

POTABLE WATER 3\"/>

IT'S THE LAW!

CALL US BEFORE YOU DIG

1-800-432-4770

SUNSHINE STATE OF FLORIDA, INC.
UTILITIES NOTIFICATION CENTER