



September 23, 2015

**Department of Planning,
Zoning & Building**

2300 North Jog Road
West Palm Beach, FL 33411-2741
(561) 233-5000

Planning Division 233-5300
Zoning Division 233-5200
Building Division 233-5100
Code Enforcement 233-5500
Contractors Certification 233-5525
Administration Office 233-5005
Executive Office 233-5228
www.pbcgov.com/pzb



**Palm Beach County
Board of County
Commissioners**

Shelley Vana, Mayor
Mary Lou Berger, Vice Mayor

Hal R. Valeche
Paulette Burdick
Steven L. Abrams
Melissa McKinlay
Priscilla A. Taylor

County Administrator

Verdenia C. Baker

Mr. Wesley Blackman, AICP, Chairman, and
Members of the Land Development Regulation Advisory Board (LDRAB)
241 Columbia Drive
Lake Worth, FL 33460

RE: September 30, 2015 LDRAB Meeting

Dear Mr. Blackman & Board Members:

Attached please find the agenda and supporting materials to assist you in preparing for the LDRAB hearing on Wednesday, September 30, 2015.

The meeting will commence at **2:00 p.m.** in the Vista Center 1st Floor Kenneth S. Rogers Hearing Room (VC-1W-47), located at 2300 North Jog Road, West Palm Beach, Florida.

If you should have any questions or require additional information, please contact me at (561) 233-5206 or via email at WCross@pbcgov.org, or Monica Cantor, Senior Site Planner at (561) 233-5205, or via email at MCantor@pbcgov.org.

Sincerely,

William Cross, AICP
Principal Site Planner, Zoning Division

Attachments: September 30, 2015 LDRAB Agenda

- c: Verdenia C. Baker, County Administrator
- Rebecca D. Caldwell, Executive Director, PZB
- Lorenzo Aghemo, Planning Director
- Robert P. Banks, Chief Land Use County Attorney
- Leonard W. Berger, Chief Assistant County Attorney
- Jon MacGillis, ASLA, Zoning Director
- Maryann Kwok, Deputy Zoning Director
- Monica Cantor, Senior Site Planner, Zoning

*"An Equal Opportunity
Affirmative Action Employer"*

U:\Zoning\CODEREV\2015\LDRAB\Meetings\9-30-15\4- Final Packet\1 - Transmittal Letter.docx

PALM BEACH COUNTY

LAND DEVELOPMENT REGULATION ADVISORY BOARD (LDRAB)

SEPTEMBER 30, 2015

BOARD MEMBERS

Wesley Blackman, AICP, Chair (PBC Planning Congress)

David Carpenter, RLA, Vice Chair (District 2)

Michael J. Peragine (District 1)

Barbara Katz (District 3)

James Knight (District 4)

Lori Vinikoor (District 5)

Stuart R. Fischer (District 6)

Henry D. Studstill, (District 7)

Daniel J. Walesky (Gold Coast Builders Assoc.)

Joni Brinkman (Palm Beach League of Cities)

Terrence N. Bailey (Florida Engineering Society)

Jerome I. Baumoehl (American Institute of Architects)

Tommy B. Strowd (Environmental Organization)

Frank Gulisano (Realtor's Assoc. of the Palm Beaches)

Gary Rayman (Fl. Surveying and Mapping Society)

Vacant (Association Gen. Cont. of America)

James M. Brake (Member at Large/Alternate)

Leo Plevy (Member at Large/Alternate)

Board of County Commissioners

Shelley Vana, Mayor, District 3

Mary Lou Berger, Vice Mayor, District 5

Hal R. Valeche
Commissioner, District 1

Paulette Burdick
Commissioner, District 2

Steven L. Abrams,
Commissioner, District 4

Melissa McKinlay
Commissioner, District 6

Priscilla A. Taylor
Commissioner, District 7

Verdenia Baker
County Administrator



"An Equal Opportunity – Affirmative Action Employer"
2300 North Jog Road, West Palm Beach, Florida 33411 (561) 233-5200



LAND DEVELOPMENT REGULATION ADVISORY BOARD (LDRAB)

WEDNESDAY, SEPTEMBER 30, 2015 AGENDA

2300 NORTH JOG ROAD

KEN ROGERS HEARING ROOM - 1ST FLOOR (VC-1W-47)

2:00 P.M.

A. CALL TO ORDER/CONVENE AS LDRAB

1. Roll Call
2. Additions, Substitutions and Deletions
3. Motion to Adopt Agenda
4. Adoption of July 22, 2015 Minutes (Exhibit A)

B. ULDC AMENDMENTS

1. Exhibit B Art. 2.A.1.J, Notification
2. Exhibit C Agriculture Recycling Privately Initiated Amendment (PIA)

C. PUBLIC COMMENTS

D. STAFF COMMENTS

1. Digital Signage Pilot Project
2. Amendment Round 2015-02

E. ADJOURN

EXHIBIT A

**PALM BEACH COUNTY
LAND DEVELOPMENT REGULATION ADVISORY BOARD (LDRAB)
LAND DEVELOPMENT REGULATION COMMISSION (LDRC)**
(Updated 7-28-15)

Minutes of July 22, 2015 Meeting

On Wednesday, July 22, 2015 the Palm Beach County Land Development Regulation Advisory Board (LDRAB), met in the Ken Rogers Hearing Room, (VC-1W-47), at 2300 North Jog Road, West Palm Beach, Florida.

A. Call to Order/Convene as LDRAB

1. Roll Call

Chair Wes Blackman called the meeting to order at 2:03 p.m. Zona Case, Code Revision Zoning Technician, called the roll.

Members Present: 12

Wesley Blackman (PBC Planning Congress)
David Carpenter, Vice Chair (District 2)
Michael J. Peragine (District 1)
Barbara Katz (District 3)
Jim Knight (District 4)
Lori Vinikoor (District 5)
Henry Studstill (District 7)
Terrence Bailey (Florida Eng. Society)
Joni Brinkman (League of Cities) *
Frank Gulisano (PBC Board of Realtors)
Tommy Strowd, (Environmental Organization)
Leo Plevy (Member at Large, Alt.)

Members Absent: 4

Daniel J. Walesky (Gold Coast Build. Assoc.)
Jerome Baumoehl (AIA)
Gary Rayman (Fl. Surveying & Mapping Soc.)
James Brake (Member At Large, Alt.)

Vacancies: 2

District 6
Assoc. General Contractors of America

County Staff Present:

Leonard Berger, Chief Assistant County Attorney
Patricia Behn, Principal Planner, Planning
John Rupertus, Senior Planner, Planning
William Cross, Principal Site Planner, Zoning
Lauren Dennis, Site Planner II, Zoning
Zona Case, Zoning Technician, Zoning

2. Additions, Substitutions, and Deletions

Mr. Blackman noted that there were no additions, substitutions or deletions.

3. Motion to Adopt Agenda

Motion to adopt the agenda by Ms. Vinikoor, seconded by Mr. Carpenter. Motion passed (11 - 0)*.

4. Adoption of May 27, 2015 Minutes (Exhibit A)

Motion to adopt by Ms. Vinikoor, seconded by Mr. Carpenter. Motion passed (11 - 0)*.

* Joni Brinkman arrives at 2:09 p.m.

B. ULDC AMENDMENTS

1. Glades Region Amendments & Art. 3.B.4, Glades Area Overlay (GAO)

Ms. Patricia Behn, from the Planning Division, presented a slide presentation and overview on the Glades Region Master Plan (GRMP), and related Comprehensive Plan Amendments. She responded to questions from the Board regarding the history of the amendment and informed the Board the Planning Transmittal hearing is scheduled for July 30, 2015. Mr. Cross presented the related Unified Land Development Code (ULDC) amendments and responded to questions from the Board. Discussion also included non-conformities.

No public comments were presented.

Motion by Frank Gulisano, seconded by Ms. Vinikoor. Motion passed (12 - 0).

C. PUBLIC COMMENTS

There were no public comments.

D. STAFF COMMENTS

Mr. Cross provided a brief update on the status of the Use Regulations Project, including that the amendments for Public and Civic Uses would be tentatively presented to the LDRAB Subcommittee in six weeks. He also stated that Zoning Staff is scheduled to update the Board of County Commissioners (BCC) on amendments to Residential and Utility uses at the September 24, 2015 Zoning Public Hearing.

EXHIBIT A

**PALM BEACH COUNTY
LAND DEVELOPMENT REGULATION ADVISORY BOARD (LDRAB)
LAND DEVELOPMENT REGULATION COMMISSION (LDRC)**
(Updated 7-28-15)

Minutes of July 22, 2015 Meeting

Mr. Blackman inquired if the August LDRAB meeting would be cancelled, to which Mr. Cross replied that this would be confirmed at a later date.

E. ADJOURN

The Land Development Regulation Advisory Board meeting adjourned at 2:44 p.m.

Recorded tapes of all LDRAB meeting are kept on file in the Palm Beach County Zoning/Code Revision office and can be requested by contacting the Code Revision Section at (561) 233-5213.

Minutes drafted by: Lauren Dennis

EXHIBIT B

ART. 2.A.1.J, NOTIFICATION
SUMMARY OF AMENDMENTS

(Updated 08/28/15)

1
2
3
4
5
6
7
8
9
10
11
12
13
14
15
16
17
18
19
20
21
22
23
24
25
26
27

Part 1. ULDC Art. 2.A.1.J.3, Signs (page 18 of 87), is hereby amended as follows:

Reason for amendments: [Zoning] Clarify that Zoning staff provides public notice information for applicants to post on notification boards consistent with the specifications in the Zoning Technical Manual to ensure uniformity in all notification signs.

CHAPTER A GENERAL

Section 1 Applicability

J. Notification

3. Signs

- a. ~~The property subject of T~~the application applicant shall ~~post have notices posted by the applicant with information of signs regarding~~ the public hearing on ~~the property subject to the application. The signs shall be prepared by the applicant using information provided by the Zoning Division, consistent with the requirements of the Zoning Technical Manual. a sign provided by the PBC Signs must be posted~~ at least 15 days in advance of any public hearing. One sign shall be posted for each 250 feet of frontage along a street up to a maximum of ten signs. All signs shall be: **[Ord. 2010-022] [Ord. 2011-016] [Ord. 2012-003]**
 - 1) Evenly spaced along the street when more than one sign per property is required; **[Ord. 2011-016] [Ord. 2012-003]**
 - 2) Setback no more than 25 feet from the property line; and, **[Ord. 2011-016]**
 - 3) Erected in full view of the public. **[Ord. 2011-016]**
- Where the property does not have sufficient frontage on a street, signs shall be in a location acceptable to the Zoning Director. The applicant shall submit photographs confirming the signs have been posted. The failure of any such posted notice to remain in place after it has been posted shall not be deemed a failure to comply with this requirement or be grounds to challenge the validity of any decision made by the approving authority. The applicant shall also be required to ensure the signs have been removed no later than five days after the final hearing. **[Ord. 2010-022] [Ord. 2011-016]**
-

Notes:

- Underlined indicates **new** text.
- ~~Stricken~~ indicates text to be **deleted**. If being relocated, or partially relocated, destination is noted in bolded brackets **[Relocated to:]** or **[Partially relocated to:]**.
- *Italicized* indicates relocated text. Source is noted in bolded brackets **[Relocated from:]**.
- A series of four bolded ellipses indicates language omitted to save space.

EXHIBIT C



PALM BEACH COUNTY
 PLANNING ZONING AND BUILDING DEPARTMENT
 ZONING DIVISION

**PRIVATELY INITIATED APPLICATION (PIA)
 AMEND UNIFIED LAND DEVELOPMENT CODE (ULDC)**

Application No. PIA 2015-01855
Title: Phase 1, Initiation of Code Amendment
Request: To Establish New Agriculture Recycling Use in the AR and AP Districts
Applicant: Equine Bedding of Florida LLC
Agent: Land Research Management, Inc.
Project Manager: William J Cross, AICP, Principal Site Planner

APPLICATION SUMMARY:

The applicant is requesting that the Board of County Commissioners (BCC) approve a request to initiate an amendment to the ULDC to be processed concurrently with ULDC Amendment Round 2015-02, as follows:

CODE SECTION	REQUIRED	PROPOSED BY APPLICANT
New Art. 4.B.1.A.3-3, Agriculture Recycling	N/A	To allow recycling of agricultural products and by-products including animal waste.
Table 4.A.3.A, Use Matrix	N/A	To allow a new Agriculture Recycling Use in the Agricultural Residential (AR) district as a Class A Conditional Use, and in the Agriculture Production (AP) district subject to DRO approval.

BACKGROUND AND SUMMARY:

While the equestrian industry is recognized as a valuable segment of the Palm Beach County economy, a number of local jurisdictions and regulating agencies have long struggled to address the adverse impacts of livestock or equestrian waste. Disposal options typically include compliance with State or County Best Management Practices (BMPs); hauling to legally established disposal facilities; or, where viable, recycling where horse bedding is sanitized and packaged for re-use.

Due to the industrial characteristics associated with the recycling of equestrian waste using the technology highlighted in the applicant’s request, the use is currently classified under Recycling Plant, which is limited to industrial zoning districts. Issues considered include the use of heavy machinery, truck traffic, and real or perceived nuisances such as odors or emissions, noise, dust, etc. (Note: The Property Appraisers Office affirmed that the use would not qualify for Agricultural Classification).

STAFF RECOMMENDATION:

Staff **does not support** allowing the proposed use within the AP or AR zoning districts; however, if the BCC directs staff to process the request, staff recommends that it be incorporated into the Use Regulations Project, tentatively scheduled for adoption in the spring of 2016, subject to the following:

- Limit recycling to equestrian waste.
- Consider limiting locations within the AP district to the Glades Area Protection Overlay (GAPO) or similar areas intended to protect the Everglades Agricultural Area (EAA) from encroachment of uses which may be detrimental to farming, conservation or everglades restoration.
- Consider the findings of any other multi-jurisdictional or agency efforts to address the equestrian waste issue, including the potential for other jurisdictions to accommodate similar agricultural waste recycling or disposal solutions.
- As acknowledged by the applicant, establish standards to limit or mitigate any potential for adverse impacts within the AR district, to include confirmation of technical specifications regarding odors or emissions generated.
- Verify applicant’s rationale for locating closer to source of equestrian waste is accomplished by locations in the AP or AR districts, to consider general location of those areas within the County known to generate the bulk of waste (emphasis on peak season) compared to proximity of existing industrialized areas where the use is currently permitted.

County Administrator
Robert Weisman



Palm Beach County Zoning Division
2300 N. Jog Road
West Palm Beach, Florida 33411
Phone: (561) 233-5200
FAX: (561) 233-5165

**ULDC PRIVATELY INITIATED AMENDMENT (PIA)
CHECKLIST**

The following documents are required as part of the application submittal:

- ULDC Privately Initiated Amendment (PIA) Application** (Form #: 80)

 - Form #80 Supplementary Table** (See Form # 80 Supplementary Table for Instructions)

 - Justification Statement** (Provide a general overview of the proposed interrelated amendments and explain the general reason for the amendments)

 - Supporting Documentation** (Provide copies of the following, if applicable:
Industry Trends, Municipal Codes, State Statutes, Federal Regulations, Other Similar)

 - Fees** (Go to: <http://www.pbcgov.com/pzb/zoning>, Click Zoning Quick Links, Click Zoning Fee Schedule.)
-

ULDC PRIVATELY INITIATED AMENDMENT (PIA) FORM #80 SUPPLEMENTARY TABLE

#	A. Article/Title	B. Proposed Amendment See footer for how to format proposed text. If Code language includes tables or figures provide as individual attachment.	C. Reason for Amendment	D. List and Attach Supporting Documentation
EXAMPLE	6.A.1.D, Off-Street Parking	<u>a. Definition</u> The use of a lot or a structure for one detached dwelling unit, excluding a mobile home but including a manufactured building.	Briefly describe what the amendment is for. Include all reasons necessary that justify the code amendment and mention the specific federal or state laws, Comp. Plan policies or regulations that created the need for the amendment.	<ol style="list-style-type: none"> 1. F.S 163.XX (Attachment 1) 2. Example of municipal zoning regulations (Attachment 2) 3. Industry Trends (Attachment 3) ...etc
1.	Article 4.B.1.A.3 & Table 4.A.3.A	3-3. Agriculture, Recycling	To allow recycling of agricultural products and by-products including animal waste in the AR District subject to Class A Conditional Use approval and in the AP District subject to DRO approval	See suggested Supplemental Standards and specifications, literature, etc. explaining and justifying the proposed amendment.
2.				
3.				
4.				
Insert additional rows if needed.				

Notes:

Underlined indicates **new** text.

~~Stricken~~ indicates text to be **deleted**. ~~Stricken and italicized~~ means text to be totally or partially relocated.

If being relocated destination is noted in bolded brackets **[Relocated to:]**.

Italicized indicates text to be relocated. Source is noted in bolded brackets **[Relocated from:]**.

.... A series of four bolded ellipses indicates language omitted to save space.

JUSTIFICATION STATEMENT

An on-going countywide effort involving local governments, regulatory agencies, special districts and other interested parties was recently initiated to address the growing issue of the treatment and disposal of equestrian waste and both Palm Beach County and Village of Wellington have developed requirements for regulating the same. Although present efforts seek to monitor and perhaps regulate the disposal of the equestrian waste stream, no recycling programs have been implemented to address the problem.

GreenScene Agritek (GSA) South Florida has developed an equestrian bedding recycling system that designed to specifically address this issue in a safe and manner consistent with resource recovery policies. Initial meetings with Palm Beach County staff to discuss a proposed location for the GSA recycling facility resulted in the direction that such a use was permitted only in the industrial zoning districts in the county. Through its relationship with Equine Bedding of Florida LCC, GSA pursued county approval to develop its recycling facility on a 5-acre site in an industrial area in suburban Palm Beach County. Although successful in obtaining the required zoning approval, Equine Bedding, as contract purchasers of the 5-acre property, was unable to come to an agreement with the owners which would have extended the schedule of the purchase agreement to allow them to obtain permanent financing. Thus Equine Bedding and GSA are looking for a suitable alternative location.

Prior to and during the development review process, GSA determined that a more suitable location for the proposed recycling facility would be in the rural or agricultural area of the county, in closer proximity to the source of the recyclable material (horse stables). Approval of the proposed amendment will allow such recycling to take place in the agricultural areas of the county.

Some components of the GSA system that will demonstrate that the proposed recycling of equestrian bedding material is appropriate for the agricultural areas is presented below.

1. Odors & emissions from the GSA system are controlled by a CamCorp bag house that traps particulates (exhibit attached). Based on data obtained from similar installations, the bag house is rated at greater than 98% removal efficiency of particulate matter from the exhaust airstream.
2. Based on review of the major source thresholds established by the Florida Department of Environmental Protection, the facility is not considered a major source of emissions, and therefore is not subject to Title V permitting requirements. All emissions fall under major source thresholds. A detailed analysis of emissions has been prepared and excerpts have been included below in table format.

3. The emissions unit is a wood chip dryer consisting of a combustion furnace/rotary drum dryer, bag house, and an induced draft fan. Incoming used horse bedding, consisting of wood chips or shavings, and wood chip fines, are separated, dried, and re-packaged for distribution. An induced draft fan pushes the shavings through concentric chambers in the rotary dryer, exposing wood shavings and bedding to a temperature of about 250OF. A portion of the wood chip fines return to the dryer for fuel. Screened shavings then are processed and bagged.
4. Used bedding, made up of wood fiber and organics, is processed in a covered building within a few days of delivery and produces little odor inside and will have less than or equal odor to that of a standard horse farm in the region.
5. The noise generated from the process is minimal and much less than a recycling facility. The noise that comes from an ID fan and the heaters / burners is within county limits. Noise is further reduced by redirecting noise from the ID fan into the bag house.
6. The process includes miscellaneous equipment for refinement and segregating of bedding materials, mixing and sizing equipment, augers and hoppers for transfer of materials, and bagging equipment. Any fine dusts generated from the miscellaneous equipment is collected and directed back to the combustion air intake for the dryer.
7. The GSA process takes used bedding made up of 80% wood fiber and organics and separates out such organics and repackages the wood fiber for resale. It is a new technology to take something used and re-package it for resale that has an agricultural benefit to the land (less phosphorous hotspots, leaching and off gassing.)

The GSA proprietary technology is not anaerobic digestion or composting. The process recycles used horse bedding that is contaminated and creates new usable high quality horse bedding. The new horse bedding is equal to, or superior, to the original material purchased by the farmer. The process has less associated odors than composting or storing the used horse bedding, and alleviates concerns such as nutrient overload and leaching associated with composting.

Emissions Table

Emissions Presented in Tons Per Year (TPY)							
	CO	NOx	PM10¹	VOCs	SO2	CO2	HAPs²
Site Potential to Emit	78.8	64.4	61.8	41.7	3.3	25,623	7.1
Anticipated Actual Emissions	32.4	26.5	25.4	17.1	1.4	10,530	2.9
Major Source Thresholds	100	100	100	100	100	100,000	25/10 ²
¹ As a conservative measure, in this application all Particulate Matter is assumed to be less than 10-microns in size, and is therefore reported as PM10.							
² HAPs emissions are presented as Total HAPs, and the corresponding regulatory threshold is 25-TPY for total HAPs, or 10-TPY for single HAP compound. Because the total HAP emission rate is less than 10-TPY, the single HAP limit is not relevant.							

Attachment 1

Florida Administrative Code (FAC)

Chapter

62-701.200 Definitions

(76) "Normal farming operations" means the customary and generally accepted activities, practices, and procedures that farmers adopt, use, or engage in during the production and preparation for market of poultry, livestock, and associated farm products; and in the production, harvesting, or packaging of agricultural crops which include agronomic, horticultural, and silvicultural crops. Included are the management, collection, storage, composting, transportation, and utilization of organic agricultural waste, manure, and materials solely derived from agricultural crops. A facility regulated as an Animal Feeding Operation pursuant to Chapter 62-670, F.A.C., that manages its manure on-site will be considered to be engaging in normal farming operations.

62-701.320 Solid Waste Management Facility Permit Requirements, General.

(1) Permit requirements. Except as otherwise provided in this chapter, no solid waste management facility shall be constructed, operated, maintained, modified, or closed without a permit issued by the Department, or by an approved local program acting under a delegation agreement with the Department.

(2) Exemptions. Except as provided in Section 403.707(2), F.S., no permit under this chapter shall be required for the following activities or facilities. For purposes of this subsection, disposal shall be deemed to include storage prior to disposal or processing.

(a) Disposal by persons of solid waste resulting from their own activities on their own property, if such waste is ordinary household waste from their residential property or is rocks, soils, trees, tree remains, and other vegetative matter which normally results from land development operations on that property. Disposal of materials that could create a public nuisance or adversely affect the environment or public health, such as white goods, automotive materials including batteries and tires, petroleum products, pesticides, solvents, or hazardous substances, is not covered under this exemption.

(b) Disposal by persons of solid waste resulting from their own activities on their property, if the environmental effects of such disposal on ground water and surface waters are:

1. Addressed or authorized by a site certification issued under Chapter 403, Part II, F.S., Electrical Power Plant Siting;

2. Addressed or authorized by a permit issued by the Department, including solid waste management permits or other environmental permits modified to include conditions for proper disposal; or

3. Addressed or authorized by, or specifically exempted from the requirement to obtain, a ground water monitoring plan approved by the Department.

(c) On-site disposal of construction and demolition debris, provided that disposal conforms to subsection 62-701.730(17), F.A.C.

(d) Disposal of solid waste resulting from normal farming operations.

Attachment 2

— **Article 4.B.1.A.3-3, Agriculture, Recycling**

Supplementary Use Standards

A use that is consistent with recycling of material associated with normal farming operations, including crop and animal waste materials.

1) Approval Process

Class A Conditional Use in AR District and DRO approval in AP District.

2) Location Criteria

a) Tier and District

AR and AP District. A rezoning of an AR District property to a standard residential district shall not be required.

b) Location

The Agriculture Recycling use shall be located on a parcel of land having direct access to an arterial road designated on the PBC Functional Classification of Roads Map.

c) Proximity to Residential Uses

The parcel or area designated on the Final Site Plan for an Agriculture Recycling use shall be located at least 500 feet from any existing residential use or approvals for PUD or TMD development areas with residential uses.

New Information

This report would like to bring the following new information forward...

1. *Technology and Company Overview*
2. *Site, Traffic, and Odour*
3. *Footprint - No Expansion*
4. *This technology is not Anaerobic and Composting*

Company Overview

Greenscene Agritek focuses on two elements of the horse farming industry:

1. Horse Bedding Waste Management; and
2. Horse Bedding Supply.

Worldwide there are an estimated 59 million horses, with Canada having approximately 900,000 horses. The average horse produces approximately three-quarters to one tonne of used horse bedding per month (4 to 7 bales per week and stalled 8 to 11 months of the year).

The company is currently in partnership with Crescent Stables and operating a pre-commercial pilot plant which is operating at 6670-64th Street in the Corporation of Delta. This plant is considered to be a pilot project. It is the company's intention to sell plants and create partnerships should this pilot project be a success.

Technology

The company's proprietary technology is not based on anaerobic digestion or composting. Further, the process only recycles used horse bedding that is contaminated and usually disposed of. The technology recycles the used horse bedding into new usable high quality horse bedding, which is equal to or superior to the original material purchased by the farmer.

Currently, the used bedding is spread on fields or used for composting, but approximately 50% of used bedding is stored on site with no suitable means of disposal. Storage and landfill disposal are no longer allowed in some jurisdictions, and there are tipping fees associated with composting.

The following are 1) a schematic of the technology and the recycling process, and 2) a flowchart. The process includes an initial material grinder, primary dryer, secondary separation and a multi-stage extraction unit, including integrated conveyors, silos, surge bins, and bailing equipment.

Fig. 1 – Technology Schematic

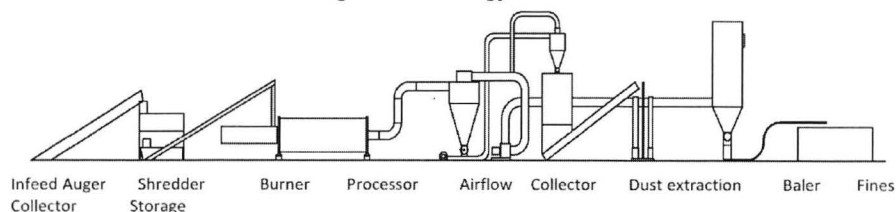
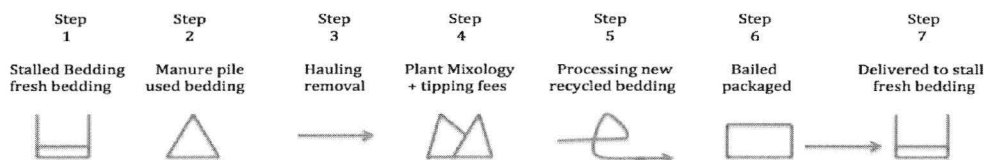

Fig. 2 – Typical Bedding Flowchart



Size, Traffic, and Odour

A site plan is attached as *Appendix A – Site Plans*, and a photo of the existing facility is attached as *Appendix B – Photo of Facility*. Additionally, please note the following:

- Traffic to the site is expected to average four trucks per day once the facility reached peak capacity;
- Each plant would be expected to operate for only two (2) or three (3) days per week; and
- There is essentially no odour associated with the recycling process. The technology has less odour than stockpiling or spreading used and wet bedding.

Footprint – No Expansion

The components of the existing facility occupy a total land area of $\frac{3}{4}$ of an acre based on the following:

- building footprint
- area for access and parking
- storage

There are no plans to expand the current facility's footprint and it is hoped that the area required for the operation would be reduced in time.

Composting and Anaerobic

The proprietary technology is neither a composting facility nor is it related to anaerobic digestion. The process takes approximately two weeks to recycle used horse bedding, as opposed to a composting facility which must store materials for approximately one year.

As such, the technology removes concerns with odours, leachate, nutrient overloading, and introduction of contaminants (problems generally associated with composting). Further, the footprint associated with this technology is significantly smaller than a composting facility.

Proposal

1. No Expansion
2. Limit Time Frame
3. Future Consideration
4. Site Visit

No Expansion

The facility is currently operating on the subject property, but has not exceeded 50% of the materials being brought in from off-site. Greenscene Agritek has no plans to expand the plant size or footprint, other than the agricultural storage of products. It is hoped in time that the footprint could be further reduced.

Time Frame

- TUP – limited to one renewal for a total time frame of six (6) years maximum
- After first three years the company would like to bring its findings back to the ALC
- After six (6) years, the findings would again be brought back to the ALC
- When affiliation with Crescent Stables ends, a facility operating with the majority of materials originating on-site may continue.

Future Consideration

As noted, the company does not plan to expand the current facility over the existing footprint. However, it should be noted that based on the success or failure of this pilot project, the company would like to look for a site that would have the greatest positive agricultural impact.

Benefits

While it is understood that the Commission recognized benefits to agriculture of the proposal, we would like to delineate some of the more relevant, and long term, benefits to horse farming in the Province of British Columbia:

- Reduce bedding and disposal costs by 30%
- Eliminate environmental concerns such as: landfill disposal, contaminant leaching, odour control, and methane off-gassing
- Recycled product is virtually pathogen and mold spore free
- Recycled product has a lower moisture content and higher absorbency than standard wood fiber bedding
- Reduced smell of ammonia
- Reduce fly populations in stables, and consequently fewer health issues

1. GSA's Agricultural-Economic Benefits

GSA has created a sustainable initiative to combat two major global problems in the equine industry: 1) the decreasing availability of good quality bedding material, and 2) the increasing cost of waste disposal.

- Reduce or eliminated spreading of used contaminated materials on active farms
- Operational cost savings
- Economics of farming and implications
- Cost management
- Reduced supply costs
- Reduced driving costs

Please see *Appendix C – Product Comparison Chart and Appendix D – Financial Projection for TUP* for product and financial information.

2. Horse Health

The recycling process eradicates the vast majority of pathogens and mold spores through computer controlled heat and time parameters. GSA is expecting to receive results of testing of mycotoxins on October 22, 2013. Mycotoxins can have negative health impacts on both humans and horses.

Horses are susceptible to respiratory illnesses, many of which can result from the impact of wet and used bedding material. GSA's process should reduce or even eliminate some of these respiratory issues.

In addition to the above, the technology would create cleaner stable environments for horses with fewer flies.

3. Environmental

Access to Wood Fiber is becoming problematic and costly as there is currently a shortage of this essential raw material currently used for horse bedding. Recycling these materials has environmental impacts which transcends the equine industry.

Please see *Appendix E – Laboratory Results and F – Horse Health Information for Health and Environmental Information*.

Stakeholders and Industry Support

Corporation of Delta – the Corporation of Delta reviewed the application in October of 2011 and recommended the following:

▪ CONCLUSION:

This non-farm use application involves a horse bedding reclaiming system at 6670 64 Street. It is recommended that the non-farm use application be supported and referred to the Provincial Agricultural Land Commission. If the Provincial Agricultural Land Commission approves this non-farm use, a Temporary Use Permit would be forwarded to Council for consideration.

Horse Council of BC – The Industry Manager of the Horse Council of BC submitted a letter to the owners offering their "endorsement of this important project".

Local Farmers – Several letters have been received from adjacent farmers also supporting the application. Two of these letters are from the properties directly south and directly west of the subject property.

A copy of the Corporation of Delta Staff Report and referenced letters are attached as Appendix G – Delta Staff Report and Letters.

Legal and Economic Issues

New environmental legislation in BC is now limiting the timeframe associated with uncovered manure to two (2) weeks. This will make composting a less viable alternative to dumping, and could lead to increased piling of organic waste on agricultural properties.

The technology offers a viable alternative to composting and dumping on a relatively small footprint.

Invitation to Commission

We believe the Commission would benefit from a tour of the existing facility, and would like to invite members of the Committee and Staff to view the operations. If this is amenable, we will co-ordinate a site tour with ALC Staff.

If possible we would also like to meet with the Commission to answer questions and give additional clarity to this proposal.

Conclusion

The proprietary technology is not anaerobic digestion or composting. The process recycles used horse bedding that is contaminated and creates new usable high quality horse bedding. The new horse bedding is equal to, or superior, to the original material purchased by the farmer.

The process has less associated odours than composting or storing the used horse bedding, and alleviates concerns such as: nutrient overload and leachate associated with composting. The proposed footprint is small and the facility is essentially temporary in nature. Traffic would have marginal increases which should not have any negative impacts on surrounding farms, and there are letters of support from some of the immediate neighbours.

We believe this technology represents a net benefit to agriculture in the Province of British Columbia reducing the footprint and negative impacts of alternatives, and provides affordable high quality solutions to an issue associated with the equine industry.

Thank you for your time and consideration.

Regards,

Ryan Anderson, Project Manager

OTG Development Concepts

Engineered to your Application

When it comes to selecting equipment to manage air quality, you need a number of alternatives that can achieve the desired result. Our air filtration systems can be designed to meet the dust collection needs of most any situation. Over the years we've repeatedly been challenged by our customers to solve impossible situations. With our years of experience and state-of-the-art capabilities, we can meet your needs.

Cleaning Technologies

- Pulse-jet (high, medium and low pressure).
- Intermittent or continuous service.
- Single or multiple compartments.

Standard Features and Options

Of course, our structural designs meet the specific technical requirements of the application, but we go the extra mile. We offer several standard features and options that are high-cost options or simply unavailable from other suppliers. Listed below are some of those notable CAMCORP features.

1. Larger pulse-jet valving and headers.
2. Inverted header pipe with drain pet-cock valve.
3. NEMA IV electricals.
4. Solid state sequential timer and Magnehelic gage mounted in common enclosure.
5. Optional round corner construction.
6. Factory assembly to fullest extent practical and shippable.
7. "Tool-less" maintenance.

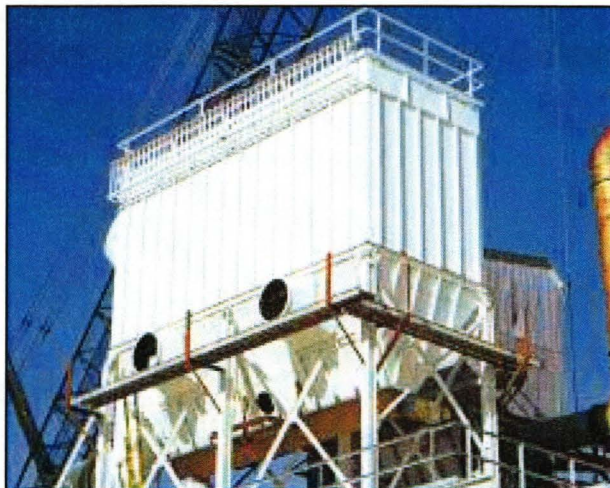



Phone: 913-831-0740
Fax: 913-831-9271
E-Mail: tracyj@camcorpinc.com
Web Site: www.camcorpinc.com

March 10, 2015

Mr. Mike Claffey
Air & Process Solutions
5834 N. 97th Street
Milwaukee, WI 53225

Fax: 414-527-3647
Ph: 414-527-9350
Email: mike@aps-wi.com

RE: Florida Project

Dear Mike:

Please find following our statement of efficiency for the above referenced baghouse project.

Based on the Pulse-Jet Baghouse Dust Collector being properly sized & applied, supplied with 16 ounce singed acrylic felt filter media, and operated in accordance with the Installation, Operation and Maintenance Manuals, the average outlet emissions will not exceed 0.01 grains per dry standard cubic foot on 2 micron and larger by weight dry particulate matter, during the life of the media. The average pressure drop of the filter should be between 2" and 4" after an initial seasoning period of 100 hours. This pressure drop can vary dramatically with operating conditions, contaminant loading, particle size and particle density.

CAMCORP, Inc. reserves the right to make any modifications, adjustments or take any other necessary corrective actions, at CAMCORP's expense, should the emissions exceed the stated values by equipment malfunction due to defects in materials and/or workmanship as supplied by CAMCORP, Inc. In no event shall CAMCORP, Inc. be liable for any incidental, special or consequential damages resulting from nonconformity.

Thank you very much Mike. I hope this will be helpful. If I may be of any further immediate service or assistance, please do not hesitate to contact me.

Very truly yours,

CAMCORP, INC.

Tracy Janssen
Vice President - Air Pollution Control

TAJ/taj

CAMCORP, INC.
9732 Pflumm Road • Lenexa, Kansas 66215

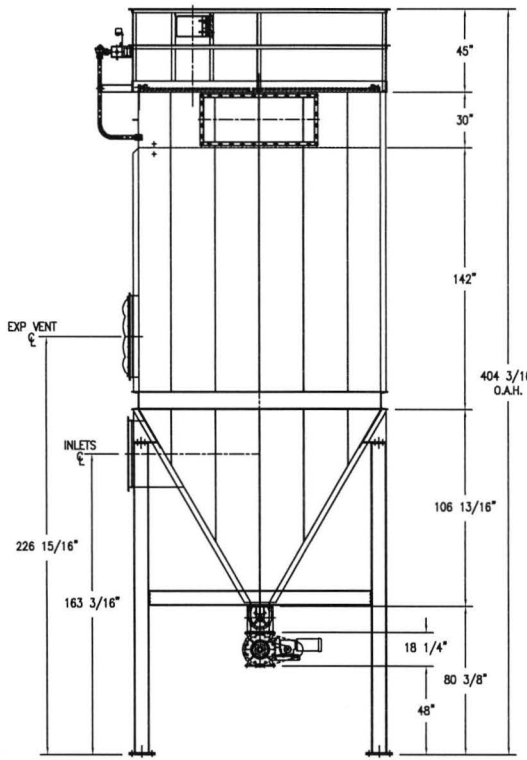
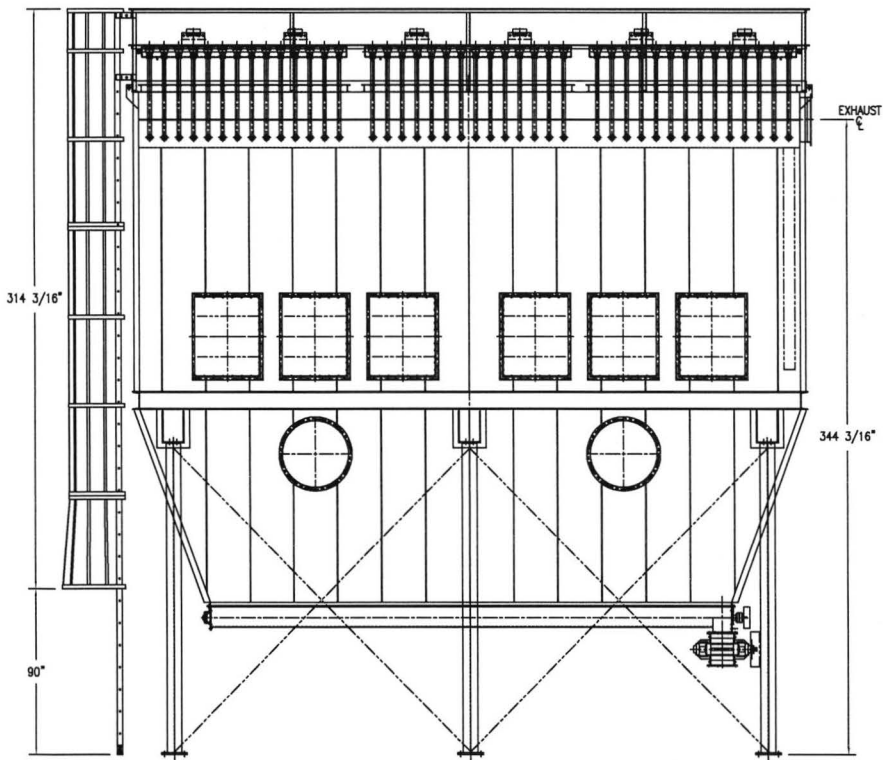
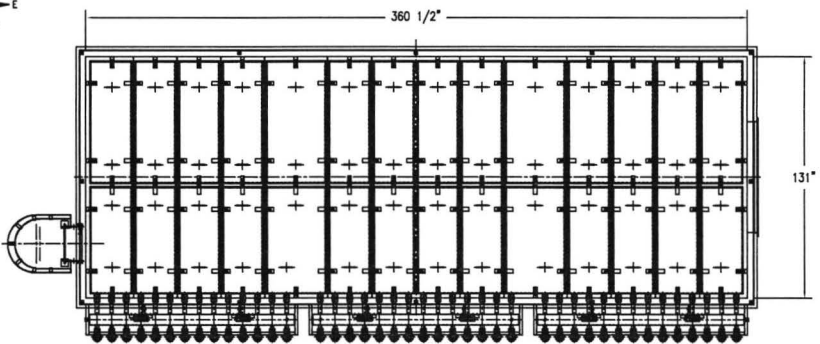

REV	DRAWING STATUS	BY	DATE
 <small>8732 PELHAM ROAD, LINDSEY, MS 39215 PHONE: 913-631-0740 FAX: 913-631-8271</small>			
<small>THIS DRAWING AND THE SOLUTIONS/DESIGNS ARE THE PROPERTY OF CAMCORP, INC. AND ARE FURNISHED ONLY FOR INFORMATIONAL PURPOSES ON A CONFIDENTIAL BASIS. REPRODUCTION, PUBLISHING, OR OTHER DISCLOSURES ARE ON A "NEED TO KNOW" BASIS ONLY. ANY OTHER REPRODUCTION REQUIRES WRITTEN AUTHORIZATION BY A CORPORATE OFFICER.</small>			
<p>FOR SALES PURPOSES ONLY</p>		<small>CUSTOMER:</small> AIR & PROCESS SOLUTIONS FLORIDA PROJECT	
<small>TITLE:</small> MODEL 42TR10X630 DUST COLLECTOR			
<small>DRAWN:</small> AJH	<small>DATE:</small> 3/17/15	<small>P.O. NUMBER:</small>	<small>REVISION:</small>
<small>JOB NUMBER:</small>		<small>DRAWING NUMBER:</small> 1203-TJ3-14	

University of Minnesota Extension

www.extension.umn.edu

612-624-1222

Horse Extension

Horse manure management and composting

Betsy Wieland, University of Minnesota Extension

Introduction

While not the most glamorous subject associated with horse ownership, manure management is a very important and inevitable part of responsible horse ownership. Manure is considered a valuable resource by many farmers for its nutrient values and soil amending characteristics. This fact sheet addresses characteristics of horse manure as well as techniques for handling, storing, composting and utilizing horse manure.

Characteristics and production

For calculation purposes, the average 1,000 pound horse eats roughly 2% of its body weight and drinks 10 to 12 gallons of water each day. This will vary with individual metabolism, activity level and the weather. On average, that same 1,000 pound horse will excrete 50 pounds of manure (feces and urine combined) each day, which adds up to 9 tons annually. In fresh manure, there is roughly 0.28 pounds of nitrogen, 0.05 pounds of phosphorus and 0.19 pounds of potassium.

Storage

Typically, manure storage consists of: short-term stockpiling, permanent stockpiling, composting or spreading the manure. Stockpiling is a pile of solid manure that is left undisturbed and may or may not be added to. Stockpiling can occur on a temporary or permanent site. A temporary stockpile must be removed and utilized within one year of the pile's creation. The site is then re-vegetated and the pile is started in a new location. This approach prevents nutrient overloading in the soil. In addition to the above listed requirements, site selection is important as there are additional requirements for soil type and separation from groundwater. A permanent stockpile is located on the same site year after year and is placed on an impervious surface such as concrete or asphalt. There are existing state guidelines for stockpiling manure that should be researched prior to establishing or constructing a manure stockpile. These guidelines are outlined in the Minnesota Pollution Control Agency



Figure 1. A manure storage bin used for composting. Note slats can be added to front for increased storage.

(MPCA) "Manure Stockpiling Technical Guidelines" ([Reference 1](#)).

Composting is actively managed from the time the pile is created, and is discussed in detail later in the fact sheet.

There are many types of manure storage facility designs that meet a barn's needs and regulatory guidelines. The type of storage facility most appropriate for a barn will vary by the number of horses, manure end use and available equipment. For barns with less than 15 horses (or where horses are in a pasture a majority of the time) a limited amount of manure will be produced. In this case, small, temporary bins or wire continuous bins work well. They are relatively compact and inexpensive to install (Figure 1).



Figure 2. Concrete manure storage pad

For barns housing 15 or more horses, manure volume increases substantially. Facility design and construction costs can be significant, but can save labor and costs in the long term. The principles are similar to smaller facilities, but access to larger equipment, sturdier designs and impervious footings are critical (Figures 2 and 3). Prior to beginning construction, contact your local county feedlot officer or MPCA feedlot contact to determine other regulatory requirements. The Soil and Water Conservation District (SWCD) or USDA Natural Resources Conservation Service (NRCS) in your county may assist you with designing and building a storage site or facility that meets your needs. (Please note that individual SWCD and NRCS offices have specific criteria required for offering technical assistance.)

Design considerations for a permanent storage unit

- Design unit for 6 months (or more) of storage.
- Ensure the front is wide enough for easy equipment access.
- Include bucking walls for equipment to push against for easier collection.
- Prevent surface water, spring melt and storm water from running into the pile.
- Consider a cover, roof or tarp to prevent excess moisture from building up.
- Use a durable floor material.
- Place in a convenient location from the barn.

An additional option for handling manure is a dumpster service. Due to the cost of rental and hauling, this option is more practical for operations that spend significant amounts of time each day on manure handling. The benefit of a dumpster is convenience. The manure is loaded into the dumpster and is switched when full. The convenience must be weighed against the extra expense of the dumpster.

Composting

Composting is **managed, accelerated decomposition** of organic materials by microbes (i.e. bacteria, fungus and molds). The goal of the composting process is to provide these microbes with an optimum environment that encourages manure decomposition quickly and efficiently. Effective composting locks in nutrients, speeds up the decomposition process, reduces the size of the pile, and kills weed seeds and fly larvae. However, if left on its own, a manure pile will eventually decompose, but nutrients will be lost, and unwanted organisms may infest the remaining compost.

Composting guidelines

Start with a good compost site. Create the site on a convenient location; ensure the site will not be flooded with water, and that the location meets the manure stockpile site requirements ([Reference 1](#)). The larger the pile, the easier it is to keep the composting process going. The storage area does not need walls, but walls do help contain the compost and allow air movement. One can be creative building walls. Pallets, chicken wire, straw bales, and boards with spaces between are options. Static piles that are not turned can be used if air is allowed in through perforated pipes. This can be passive or forced with blowers. Design guidelines for larger manure storage sites can often be used for smaller compost bins as well.

Get compost ingredients. Table 1 has a list of ingredients needed in horse manure compost piles. Table 2 lists materials that can and cannot be composted. Use plant materials like wood shavings, leaves, etc. (Figure 4) Pet waste, fats, and meats are not recommended.

Table 1. Common compost ingredients

Carbon	wood shavings, straw, sawdust, manure
Nitrogen	urine, manure, fresh plant material (lawn clippings, freshly pulled weeds), ammonium sulfate
Air	2/3 of the pile volume should be air. Large woodchips can be used to fluff. Sift when done.
Water	moisture like a wrung out sponge, wet but not dripping
Mix Well	Microbes have better access to materials with more evenly mixed materials.



Figure 3. Compacted clay composting pad



Figure 4. An example of well mixed raw

Table 2. Can I compost this? Materials that should and should not be used in compost for disease control.

Useful	Not Useful
Manure	Diseased plants**
Garden waste	Animal mortalities***
Some kitchen waste*	Dog or cat feces***
Lawn clippings	Fats***
Leaves	Meat***

* Vegetables, fruit, coffee grounds, unbleached coffee filters, tea bags, eggshells, bread, etc.

** Many fungi and spores are not killed in the composting process. Adding them can spread the disease further.

*** Experienced composters can compost these, but appropriate temperatures MUST be reached.

Blend compost materials well. Mixing the compost gives the microbes access to all necessary nutrients.

Add water as the materials are mixed to reach a moisture level similar to a wrung out sponge. Add water during the mixing process as it is difficult to add water throughout the pile after the compost is mixed.

Cook. Monitor temperatures and remix the pile as needed. The mixture is correct if the pile heats to between 140° and 160° F and sustains that temperature for 3 weeks. A temperature probe, which can be purchased from many farm supply stores, is ideal for monitoring the temperature. Turn the pile if temperatures exceed 160° F or when temperatures begin to decline. A lower temperature is usually an indication of missing ingredients; often more nitrogen or water is needed. Remix after adding the needed ingredients. The composting process is nearly complete when it does not heat after mixing and the original ingredients are no longer recognizable. Note that it may not be possible to maintain desired temperatures during winter months in Minnesota. Manure can be stockpiled over winter and composting can resume in the spring.

Let cool. Compost curing occurs in the last 1 to 2 months, during which time the temperature will reduce to ambient levels. Depending on the size of materials used, the finished product will look like something between potting soil and large, dark brown wood chips. Finer materials do compost more quickly.

Use. Use the finished compost as a soil amendment in a garden; tree mulch; potting soil; or fertilizer for the yard, pasture or hay fields. When spreading compost on a yard, pasture or hay field, never spread more than 1/2" of compost at one time.

See the "Additional Information" section to learn more about composting.

Utilization options

Whether composted or not, eventually manure will need to be moved and utilized. There are two main options for manure utilization. Manure can be used on site by spreading it as a fertilizer on an open area, pasture or field. Alternately, manure can be hauled off site for either fertilizer use or composting. Caution should be used when spreading manure on pastures that are grazed by horses. Manure should not be spread on pastures where the stocking rate exceeds 1 horse per 2 acres. Spreading manure in heavily stocked pastures could result in increased parasite exposure.

Spreading

Spreading the manure for its fertilizer value is an excellent way to utilize it. However, caution must be used so excessive nutrient accumulation is avoided. There are three steps to determine how much manure can be spread on a particular field. First, determine the nutrient content of the manure. Several private labs can perform this test. Second, test the soil where the manure will be spread to determine how much manure is needed by a particular crop. Spread only as much manure as needed to produce a viable and maximum yielding crop. For assistance in calculating the manure nutrient content, soil requirements and crop needs, consult your local County Extension Office. More detailed information can be attained through the MPCA fact sheet "Land Application of Manure: Minimum State Requirements" ([Reference 2](#)).

Develop a manure management plan

All horse facilities should have a manure management plan (regardless of size). The plan should include the following:

- Estimation of annual animal manure production
- Estimation of annual nutrient production

- Plans for collecting, handling and storing
- Emergency action plan that quickly deals with accidental manure spills or other environmental emergencies
- If the manure will be land applied, include the following in addition to the above:
 - Estimation of annual crop nutrient utilization potential
 - Cropping rotation
 - Land available for application throughout the year

Reference

1. Minnesota Pollution Control Agency. "Manure Stockpiling Technical Guidelines."
2. Minnesota Pollution Control Agency. "Land Application of Manure: Minimum State Requirements." Available at:

Additional information

University of Minnesota. Manure Management and Air Quality. Available at: www.manure.umn.edu

Hamilton, D.W. "Composting Systems for Small Horse Farms." Oklahoma State University Cooperative Extension Service. Available at: <http://pods.dasnr.okstate.edu/docushare/dsweb/Get/Document-2070/BAE-1729web.pdf>

Rynk, R. On-Farm Composting Handbook. Natural Resource, Agriculture, and Engineering Service (NRAES) NRAES-54. Midwest Plan Services. Available at: www.mwps.org/

[University of Minnesota Horse Website](#)

Wegner, T. and Halback, T. 2000. "[Manure and Pasture Management for Recreational Horse Owners.](#)" University of Minnesota Extension.

Wheeler, E. [Horse Facilities Handbook](#). Midwest Plan Services.

Wheeler, E. "[Horse Stable Manure Management.](#)" Penn State Cooperative Extension.

Reviewers: Tom Tweeten, Ph.D., Minnesota Horse Council; Krishona Martinson, Ph.D., University of Minnesota; and Samantha Adams, Minnesota Pollution Control Agency. Photo Credits: Hennepin Conservation District (figure 1); and Betsy Wieland, University of Minnesota Extension (figures 2, 3 and 4).

UNIVERSITY OF MINNESOTA
EXTENSION

NEWSPAPERS

- LOG IN REGISTER



SEARCH

- NEWS BUSINESS SPORTS ENTERTAINMENT LIFESTYLE HEALTH TRAVEL

- Don't Miss: Happening Now Video Centre Live chats Blogs on canada.com canada.com on Facebook Oddities

Manure recycling smells like success

A Langley man may have found a way to turn horse manure into green gold.

By The Vancouver Sun March 26, 2008

- [Story](#)
- [Photos \(1\)](#)

Like 2 people like this. [Sign Up](#) to see what your friends like.

Manure recycling smells like success

A Langley man may have found a way to turn horse manure into green gold.

In February, GreenScene Pellets Inc. began recycling manure with technology that converts fly-laden horse waste into a dry, pathogen-free byproduct for use as bedding material for horses and other animals or fuel for greenhouse operations.

Although the operation is still in the startup phase, company founder Phil Wilford believes he will make \$300,000 selling the bedding pellets in the next year and up to \$5 million in a few years time when he starts marketing the complete package including the recycling plant.

He said its the first processing plant of its type in Canada.

"There are 75,000 horses in the Fraser Valley," Wilford noted in an interview. "They make 400,000 to 500,000 tons of manure a year. We're taking something that's smelly and impossible to get rid of and turning it into a viable byproduct that they can use in the industry."

He said the process also reduces greenhouse gases and helps eliminate manure stockpiling and groundwater contamination.

Wilford, who is working on the project with the B.C. Horse Council, is now partnering with Crescent Stables Ltd. in Ladner for his first drying and shredding plant, with animal waste from the farm used as feedstock for the system.

The byproduct is used as bedding at the host farm, with the excess sold to other horse farms or nearby greenhouses.

Wilford, who previously built machines to clean contaminated soil, built his demonstration machine by modifying a plant used to remove sewage sludge.

So far, he's spent \$350,000 developing the company.

Wilford, whose recent projects include working with the B.C. Ministry of Agriculture to develop an efficient method of disposing of poultry during an avian influenza outbreak in 2004 and 2005, said he's getting interest in the manure recycler from many parts of the world -- including Brazil, Mexico and Europe -- and that he believes there's room for 10 to 12 of his recycling plants in B.C. alone.

He estimates that each complete plant will sell for about \$750,000 and that several farms will eventually buy one recycler together.

"One of the biggest problems in the agriculture industry is getting rid of horse manure," he said. "So I developed a system for drying and shredding horse manure, removing the pathogens and turning it back into bedding material for horses and other animals."

Wilford said sawdust is now used for bedding, but it's poor quality, gets wet easily and promotes mould spores, which get into horses' lungs. Sawdust, he said, contains 49 per cent moisture, while his manure byproduct is just 11 per cent moisture. "It removes the spores and it's absolutely clean."

Wilford has had his share of challenges starting up GreenScene Pellets. "Raising sufficient capital was the biggest challenge. Also, educating the industry to accept recycled manure.

"And we need more investment."

bmorton@png.canwest.com